

Your partner in spine surgery

**NEURO FRANCE** Implants  
Spine

Distribuído por :



**NEW SURGICAL**  
compromisso com a saúde e a vida

NEURO FRANCE Implants - Fabricante e designer de implantes para cirurgias de coluna

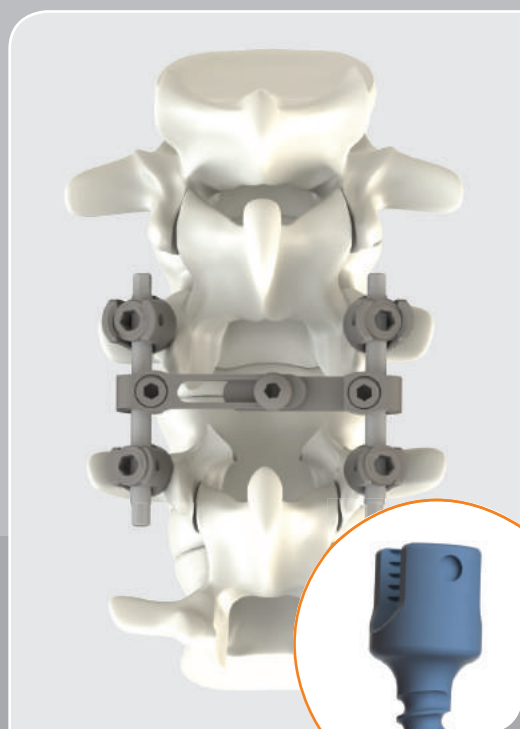

*Km*

*SISTEMA DE FIXAÇÃO  
TORACOLOMBAR*

**CE**  
MARK

**ISO**  
13485 : 2016

**NEURO FRANCE Implants**

ZA «le Bourg» - 25 rue des écoles 41160 La Ville aux Clercs - FRANCE

Phone : +33 2 54 80 90 90 - Fax : +33 2 54 80 83 33

Email : [neurofrance@neuro-france.net](mailto:neurofrance@neuro-france.net)

# SISTEMA KM

## PONTOS PRINCIPAIS :

- Abordagem posterior
- Sistema de barras (5 e 6 mm)
- Parafuso monoaxial e poliaxial
- Parafuso para espondilolistese
- Escoliose
- Compatibilidade com sistema KM BABY para fixação da transição cervico-torácica
- Compatibilidade com sistema SES para correção de deformidades

## SISTEMA DE FIXAÇÃO TORACOLOMBAR



## INDICAÇÕES

Coluna degenerativa  
Traumas  
Tumores  
Escoliose/deformidades  
Espondilolistese

## COMPOSIÇÃO DO SISTEMA

Parafuso monoaxial e poliaxial  
Parafuso monoaxial e poliaxial espôndilo  
Gancho  
Cross Link  
Conectores  
Set Instrumental



## MATÉRIA PRIMA UTILIZADA

Todo sistema KM é fabricado em liga de titânio Ti 6-Al 4-V, em conformidade com a ISO 5832/3.

# KM - IMPLANTES

## PARAFUSO MONOAXIAL KM



Item n°	Ø Diam.	Comp. (L)	Cor*
204530	Ø 4,5 mm	L 30 mm	■
204535	Ø 4,5 mm	L 35 mm	■
205535	Ø 5,5 mm	L 35 mm	■
205540	Ø 5,5 mm	L 40 mm	■
205545	Ø 5,5 mm	L 45 mm	■
206535	Ø 6,5 mm	L 35 mm	■
206540	Ø 6,5 mm	L 40 mm	■
206545	Ø 6,5 mm	L 45 mm	■
206550	Ø 6,5 mm	L 50 mm	■
206555	Ø 6,5 mm	L 55 mm	■
207540	Ø 7,5 mm	L 40 mm	■
207545	Ø 7,5 mm	L 45 mm	■

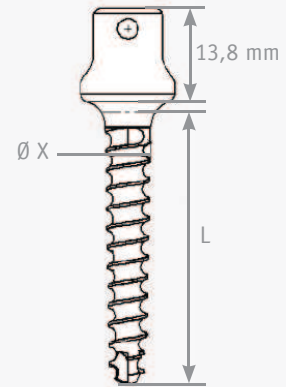

## PARAFUSO POLIAXIAL KM



Item n°	Ø Diam.	Comp. (L)	Cor*
224525	Ø 4,5 mm	L 25 mm	■
224530	Ø 4,5 mm	L 30 mm	■
224535	Ø 4,5 mm	L 35 mm	■
224540	Ø 4,5 mm	L 40 mm	■
225530	Ø 5,5 mm	L 30 mm	■
225535	Ø 5,5 mm	L 35 mm	■
225540	Ø 5,5 mm	L 40 mm	■
225545	Ø 5,5 mm	L 45 mm	■
226535	Ø 6,5 mm	L 35 mm	■
226540	Ø 6,5 mm	L 40 mm	■
226545	Ø 6,5 mm	L 45 mm	■
226550	Ø 6,5 mm	L 50 mm	■
226555	Ø 6,5 mm	L 55 mm	■
227535	Ø 7,5 mm	L 35 mm	■
227540	Ø 7,5 mm	L 40 mm	■
227545	Ø 7,5 mm	L 45 mm	■
227550	Ø 7,5 mm	L 50 mm	■
227555	Ø 7,5 mm	L 55 mm	■
227560	Ø 7,5 mm	L 60 mm	■

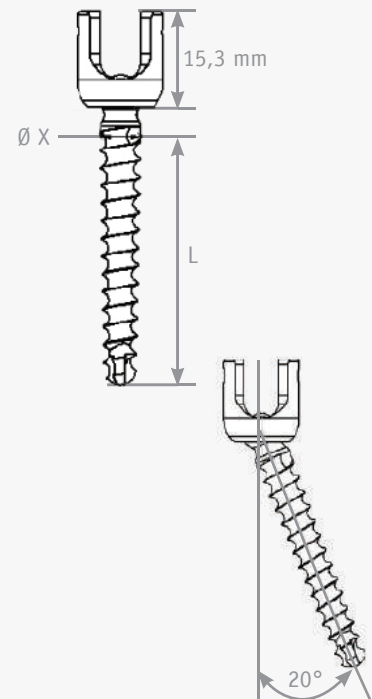

\* Cores sob encomenda.  
Parafusos auto-macheantes  
Cada parafuso e gancho é fornecido com uma porca (550300)



Fotos meramente ilustrativas

# KM- IMPLANTES

## PARAFUSO MONOAXIAL ESPÔNDILO KM



Item n°	Ø Diam.	Comp. (L)	Cor*
216540	Ø 6,5 mm	L 40 mm	■
216545	Ø 6,5 mm	L 45 mm	■
217540	Ø 7,5 mm	L 40 mm	■
217545	Ø 7,5 mm	L 45 mm	■

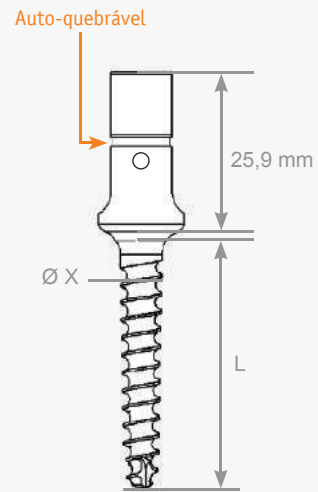

## PARAFUSO POLIAXIAL ESPÔNDILO KM



Item n°	Ø Diam.	Comp. (L)	Cor*
235545	Ø 5,5 mm	L 45mm	■
236540	Ø 6,5 mm	L 40mm	■
236545	Ø 6,5 mm	L 45mm	■
236550	Ø 6,5 mm	L 50mm	■
236555	Ø 6,5 mm	L 55mm	■
237540	Ø 7,5 mm	L 40mm	■
237545	Ø 7,5 mm	L 45mm	■
237550	Ø 7,5 mm	L 50mm	■
237555	Ø 7,5 mm	L 55mm	■

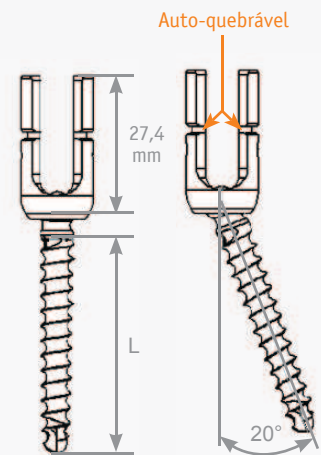

## GANCHO KM



Item n°	Descrição	
200000	Gancho pedicular	1
200010	Gancho Laminar Lombar	2
200020	Gancho Laminar Torácico	3



\* Cores sob encomenda.  
Parafusos auto-macheantes  
Cada parafuso e gancho é fornecido com uma porca (550300)

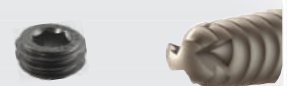

Fotos meramente ilustrativas

# IMPLANTES CONECTORES

## BARRAS COM EXTREMIDADE HEXAGONAL Ti 6-Al 4-V

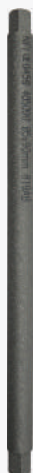

### Ø 5mm

Item n°	Comp. (L)
---------	-----------

405045	L 45,5 mm
405055	L 55,5 mm
405065	L 65 mm
405075	L 75 mm
405090	L 90 mm
405105	L 105 mm
405125	L 125 mm
405154	L 154 mm
405180	L 180 mm
405200	L 200 mm
405210	L 210 mm
405220	L 220 mm
405230	L 230 mm
405240	L 240 mm
405250	L 250 mm
405270	L 270 mm
405290	L 290 mm
405300	L 300 mm
405320	L 320 mm
405400	L 400 mm
405450	L 450 mm
405480	L 480 mm



### Ø 6mm

Item n°	Comp. (L)
---------	-----------

406045	L 45,5 mm
406055	L 55,5 mm
406065	L 65 mm
406075	L 75 mm
406090	L 90 mm
406105	L 105 mm
406125	L 125 mm
406154	L 154 mm
406180	L 180 mm
406200	L 200 mm
406210	L 210 mm
406220	L 220 mm
406230	L 230 mm
406240	L 240 mm
406250	L 250 mm
406270	L 270 mm
406290	L 290 mm
406300	L 300 mm
406320	L 320 mm
406350	L 350 mm
406375	L 375 mm
406400	L 400 mm
406425	L 425 mm
406450	L 450 mm
406480	L 480 mm

# IMPLANTES CONECTORES

## CROSS LINK ARTICULADO



Item n°	Descrição
501029	De 29 a 35 mm
501034	De 34 a 45 mm
501044	De 44 a 65 mm
501064	De 64 a 105 mm

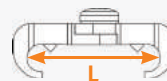

Cada cross link é fornecido com 3 porcas



## CONECTOR CILÍNDRICO



Item n°	Furos	Descrição
520256	4	Ø5/6mm (Inclui 4 porcas de fenda estrela)
520266	4	Ø6/6mm (Inclui 4 porcas de fenda estrela)



Cada conector é fornecido com 4 porcas que possuem o mesmo número de lote do conector



# IMPLANTES CONECTORES

## CONECTOR QUADRADO



Item n°	Furos	Descrição
521035	4	Ø3/5mm (Inclui 4 porcas de fenda estrela)
521036	4	Ø3/6mm (Inclui 4 porcas de fenda estrela)
521056	4	Ø5/6mm (Inclui 4 porcas de fenda estrela)
521066	4	Ø6/6mm (Inclui 4 porcas de fenda estrela) <i>Item em fase de registro na Anvisa</i>



As porcas são fornecidas com o conector e possuem o mesmo número de lote do conector



# KM- INSTRUMENTAIS

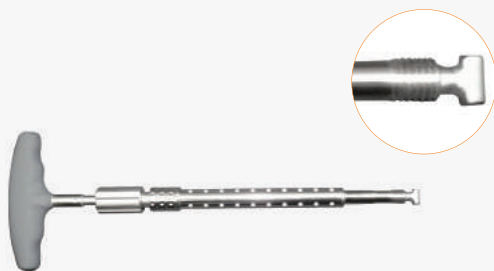

010100N Chave para Parafuso Monoaxial KM/CTJ



010200N Chave para Parafuso Poliaxial KM/CTJ

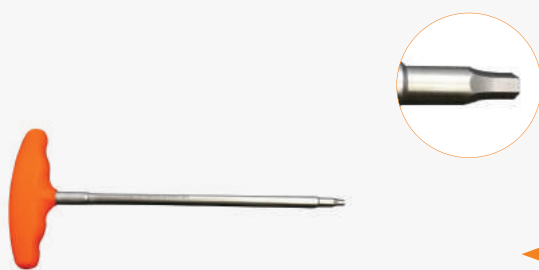

010500 Chave para Porca KM/CTJ



010505N Chave para Porca KM/CTJ - Não Cônico

*Item em fase de cadastro na Anvisa*

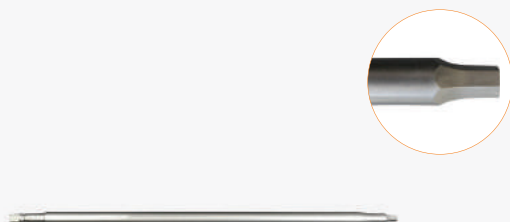

010505 Chave para Porca KM



010505M Chave para porca KM - Não cônico

*Item em fase de cadastro na Anvisa*

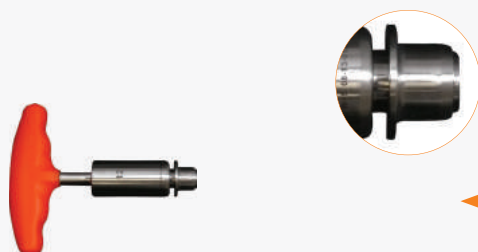

010503012 Torquimetro com Cabo em T

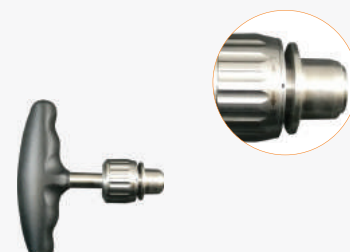

010000N Torquimetro - Cabo com Mecanismo de Catraca em T

*Item em fase de cadastro na Anvisa*



# KM- INSTRUMENTAIS



010601

Chave Anti-Rotação para Cabeça de Parafuso KM/CTJ

OR

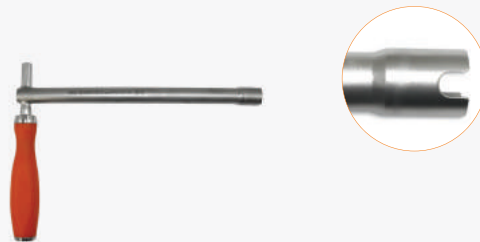

010610L

Chave Anti-Rotação para Cabeça de Parafuso KM/CTJ

*Item em fase de cadastro na Anvisa*

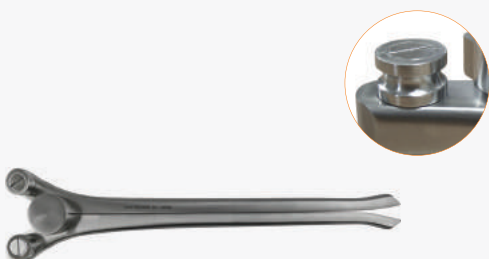

011100

Alicate Dobra Barra

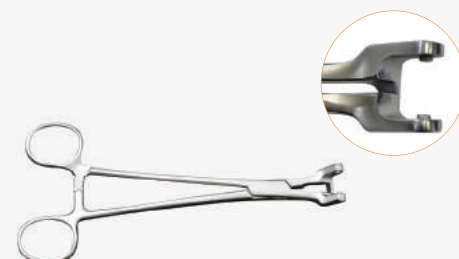

011300

Posicionador para Barra KM/CTJ

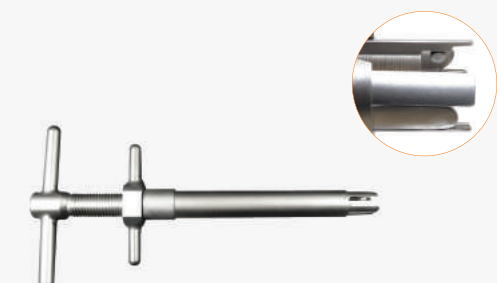

011301

Posicionador para Barra de Escoliose



011400

Derrotador de Barra



011410

Modelador para Barra - Direito



011411

Modelador para Barra - Esquerdo

*Fotos meramente ilustrativas*

# KM - INSTRUMENTAIS



013140

Macho de 4mm



015306

Pinça para Barra de 6mm

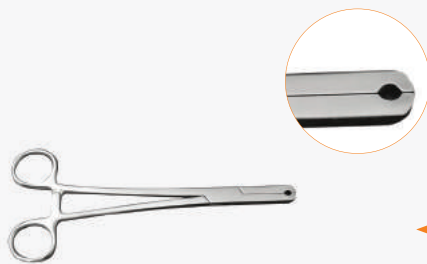

015206

Pinça para Barra de 6mm

OR

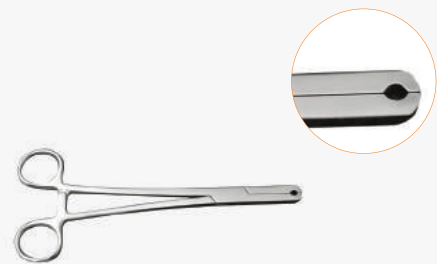

015207

Pinça para Barra de 5 e 6mm

*Item em fase de cadastro na Anvisa*

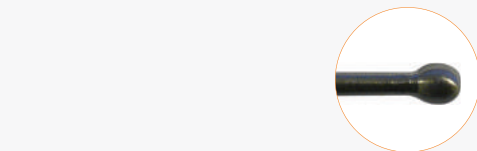

016103

Apalpador de Pedículo

*Item em fase de cadastro na Anvisa*

OR

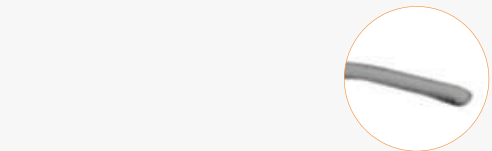

016100

Apalpador de Pedículo



016203C

Probe Curvada - Pequena



016202C

Probe Reta - Pequena

# KM- INSTRUMENTAIS



010491

*Item em fase de cadastro na Anvisa*  
Segurador de Porca



010492

*Item em fase de cadastro na Anvisa*  
Segurador de Barra



012101

Pinça de Distração Paralela KM/CTJ

OR



012102

*Item em fase de cadastro na Anvisa*  
Pinça de Distração Paralela KM/CTJ



012201

Pinça de Compressão KM/CTJ

OR



012202

*Item em fase de cadastro na Anvisa*  
Pinça de Compressão Paralela KM/CTJ



018000

Preparador para Gancho Tóraco Laminar  
KM



018010

Preparador para Gancho Lombar Laminar  
KM

# KM - INSTRUMENTAIS



018020 Preparador para Gancho Pedicular

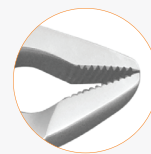

015406 Pinça de Aperto para Barra 6mm



010551 Chave 3,5mm para Cross Link Articulado



010540 Chave para Parafuso TORX - Fenda Estrela

# KM- INSTRUMENTAIS



014101

Iniciador KM



014111

*Item em fase de cadastro na Anvisa*  
Iniciador KM Graduado



014102

Iniciador com Bloqueio



010602

Garfo Anti-Rotação para Cabeça de Parafuso KM/CTJ



015106

Abaixador de Barra



015107

*Item em fase de cadastro na Anvisa*  
Abaixador de Barra



013150

Macho de 5mm

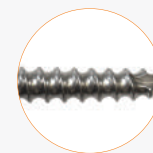

013160

Macho de 6mm

# CONTAINER PARA TRANSPORTE

## INSTRUMENTAIS KM CONTAINER DE TRANSPORTE



Item n° : 000030

SUBSTITUÍDO POR :



Item n° : 0B0806

*Item em fase de cadastro na Anvisa*

## IMPLANTES KM CONTAINER DE TRANSPORTE



Item n° : 000031

SUBSTITUÍDO POR :



Item n° : 0B0807

*Item em fase de cadastro na Anvisa*

# ANOTAÇÕES

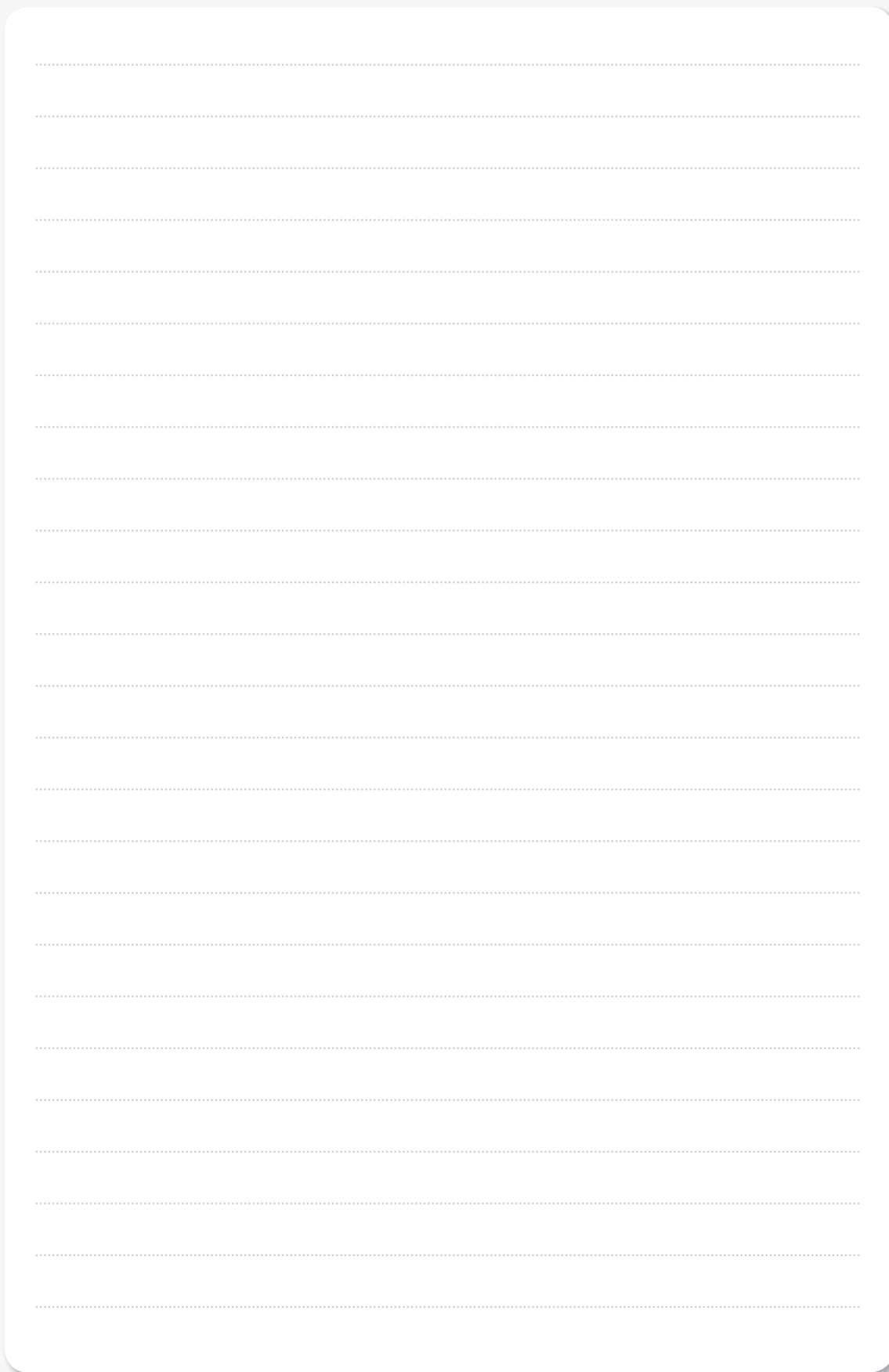

Your partner in spine surgery

# NEURO FRANCE Implants



## Spine

[www.neuro-france.net](http://www.neuro-france.net)

### NEURO FRANCE Implants

ZA «le Bourg» - 25 rue des écoles 41160 La Ville aux Clercs - FRANCE

Phone : +33 2 54 80 90 90 - Fax : +33 2 54 80 83 33

Email : [neurofrance@neuro-france.net](mailto:neurofrance@neuro-france.net)



[www.neuro-france.net](http://www.neuro-france.net)

Distribuído por :



**NEW SURGICAL**

*compromisso com a saúde e a vida*

Rua Antônio Ataíde, 823 Ed. Tropical Shopping  
Sala 403 - Centro de Vila Velha, ES, 29100-906  
Tel (27) 30772772